

# 成品示意图 360° VIEW PICTURE

# 组装基本步骤示意图 ASSEMBLE THE BASIC STEP DIAGRAM

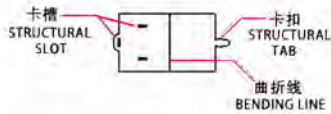

## 糖果屋 CANDY HOUSE

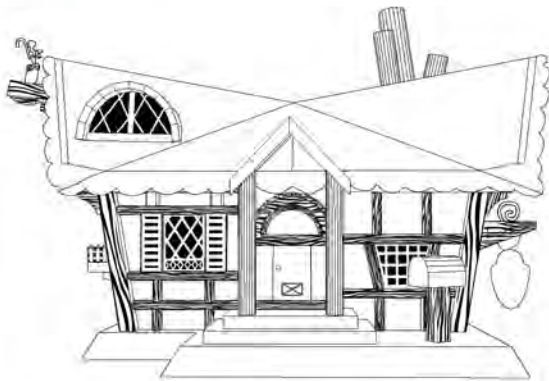

固定方式一：  
将卡扣穿过对应固定孔，  
按对应角度曲折（图一）  
Fitting method 1:  
put the tab in the slot,  
bend properly(p1)



折弯面  
Bending surface

固定方式二：  
将卡扣穿过对应固定孔，  
用钳子类工具垂直扭曲固  
定卡扣（图二）  
Fitting method 2:  
put the tab in the slot,  
bend the tab vertically  
with pier(p2)



纹理面  
Texture surface

非纹理面  
Non - textured surface



组装前请戴上指套！  
Please wear a finger cover before assembly!



板件上刻有编号  
Sheet metal pieces of the engraved with serial number

## 金属部件 METAL PARTS -A

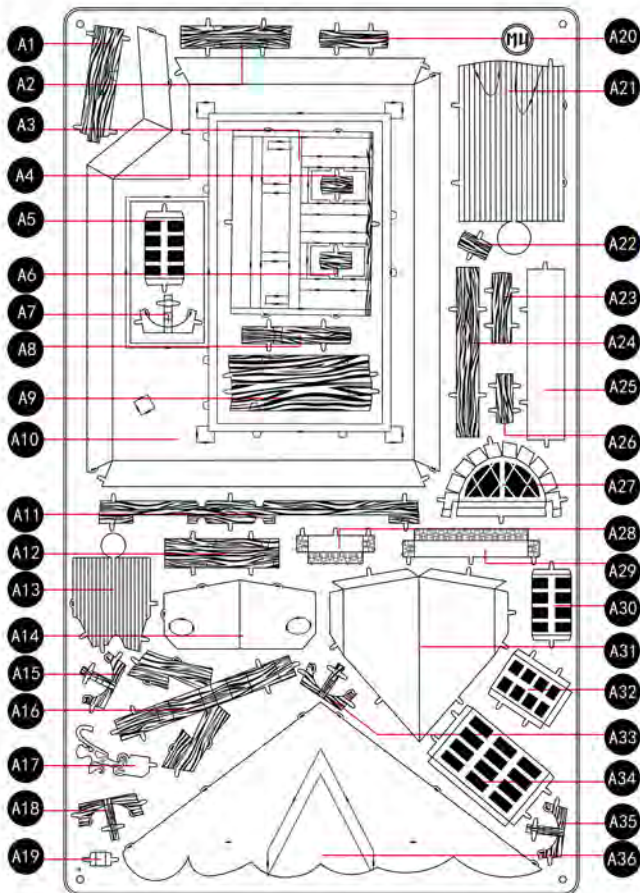

## 金属部件 METAL PARTS -B

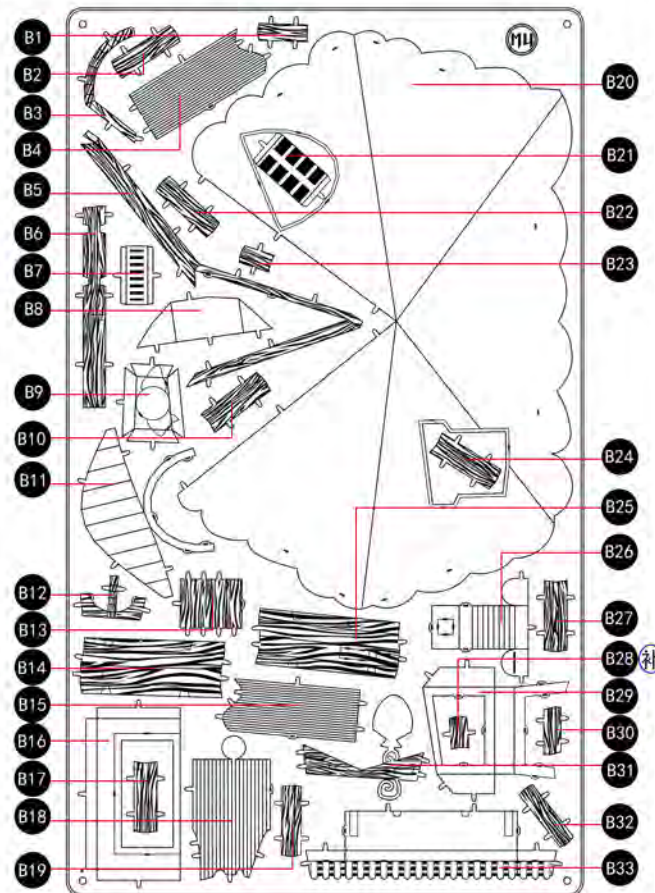

金屬零件 METAL PARTS - C

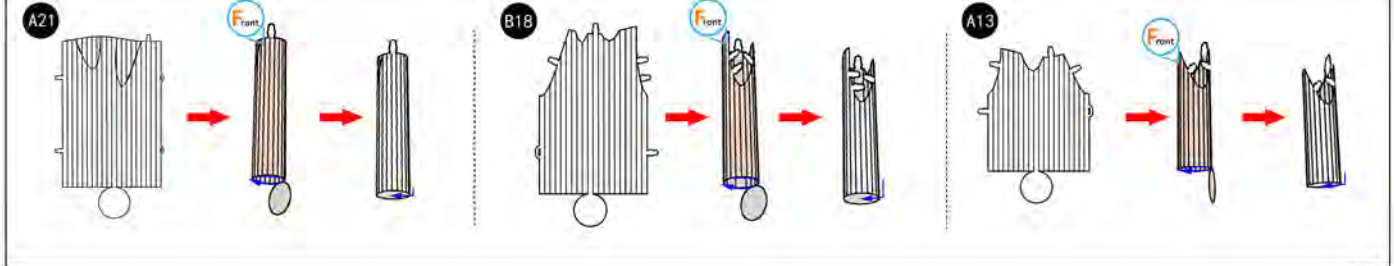
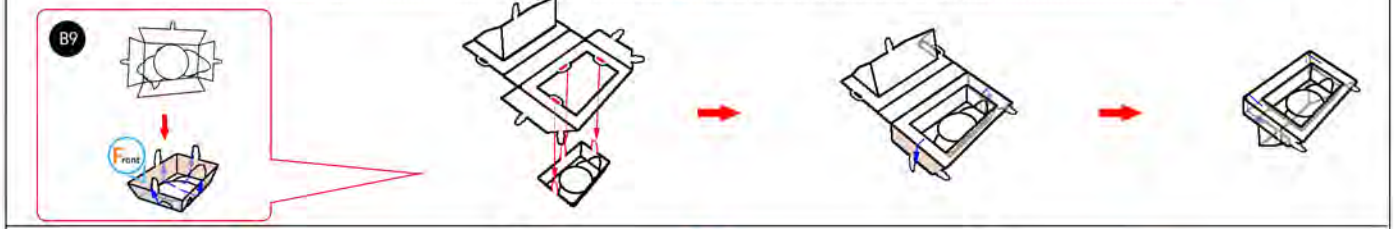
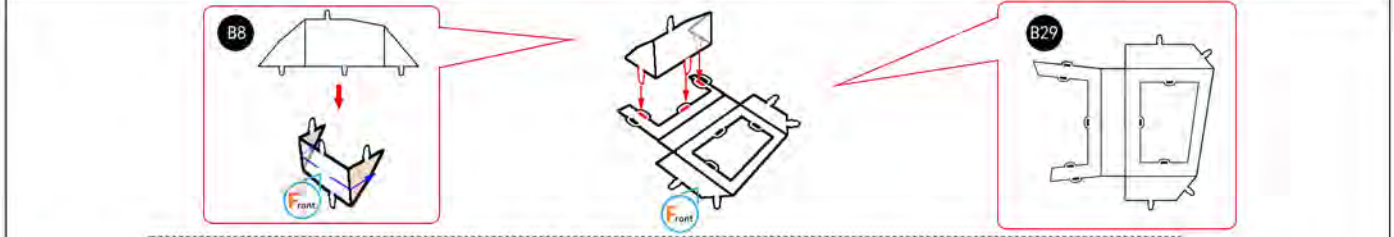
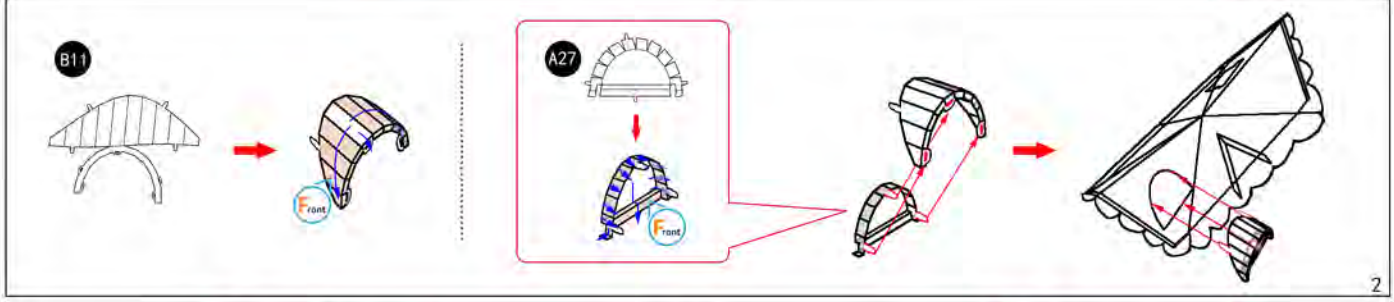
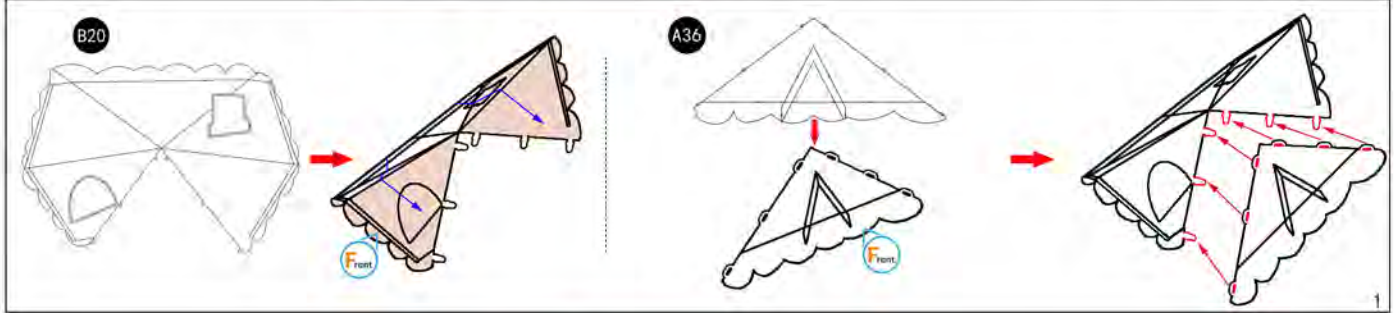
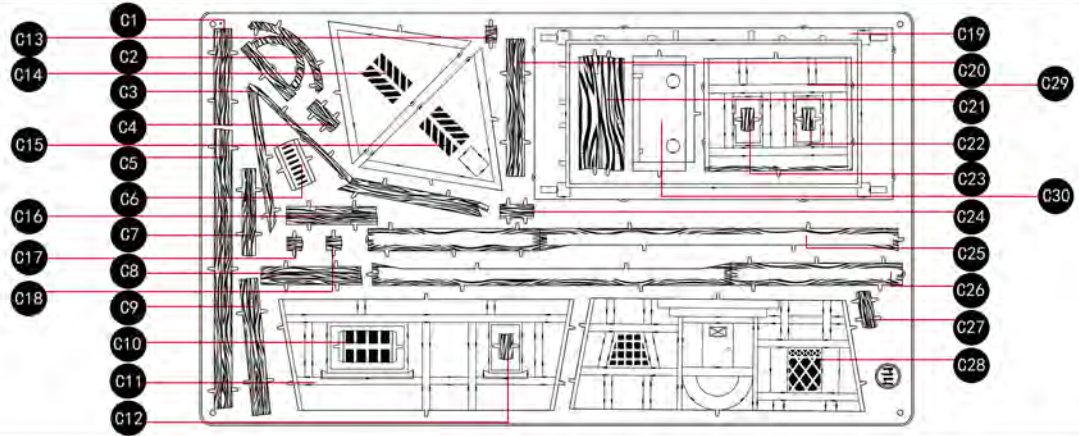

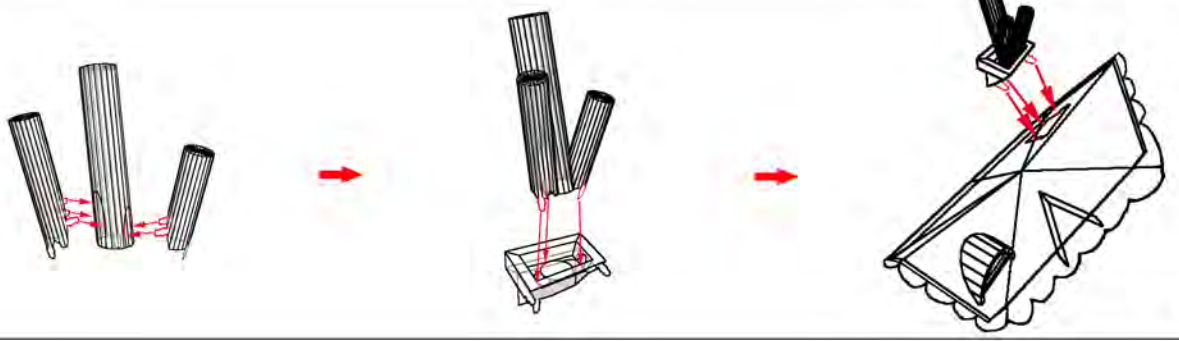

3

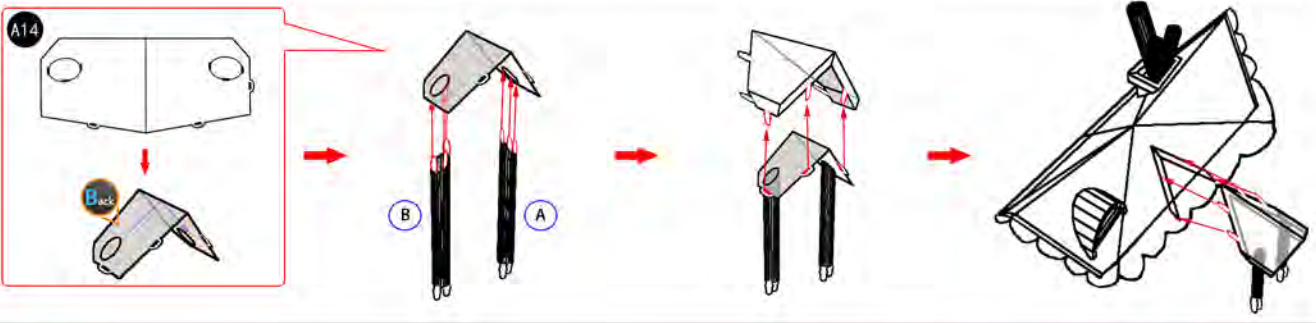
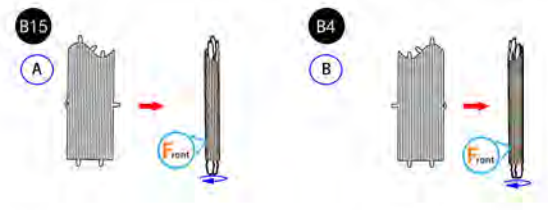
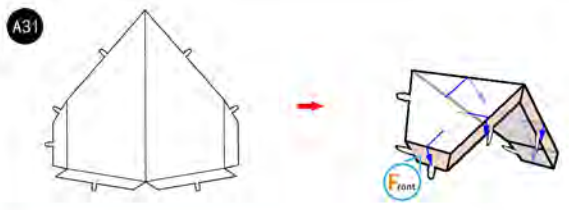

4

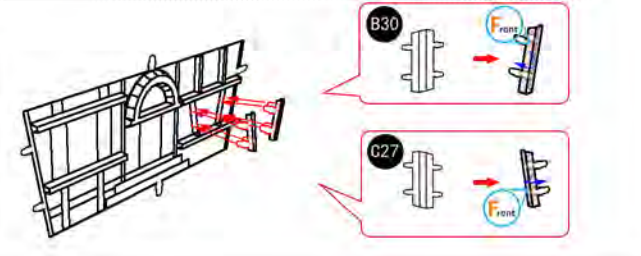
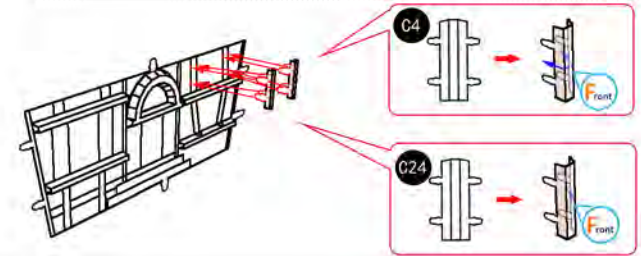
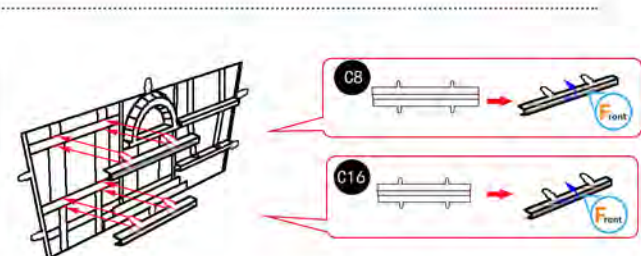
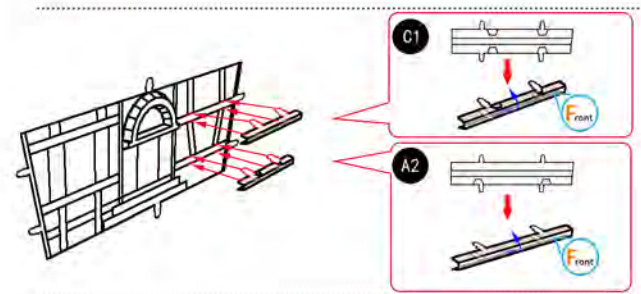
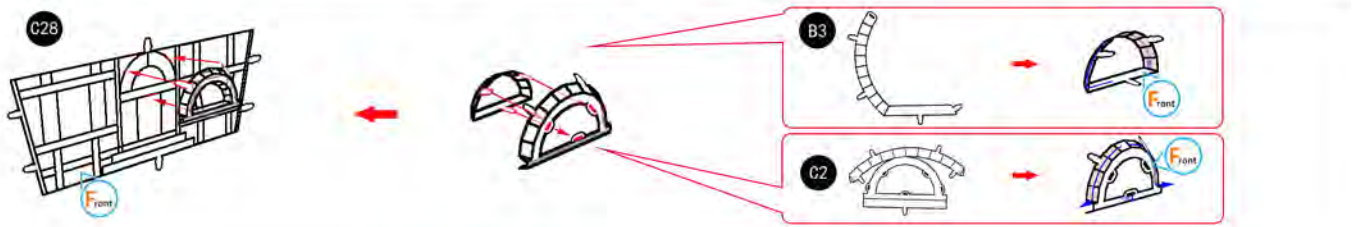

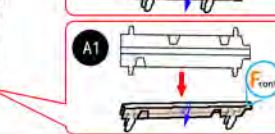
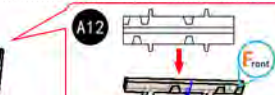
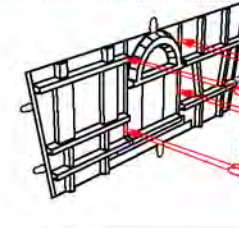
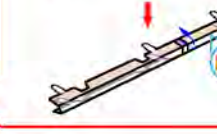
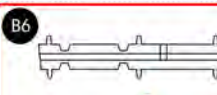
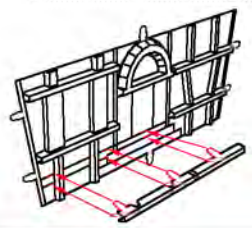
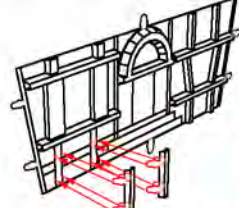
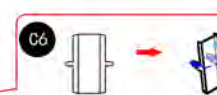
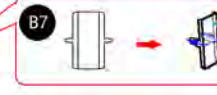
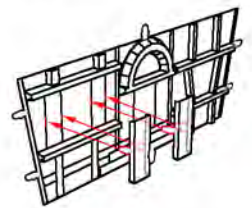
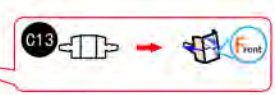
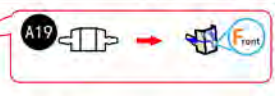
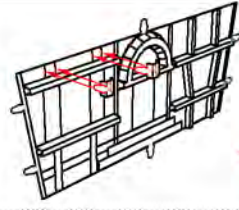
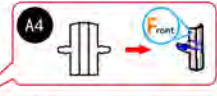
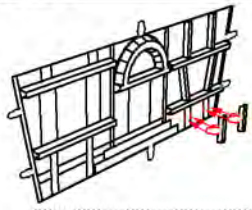

5

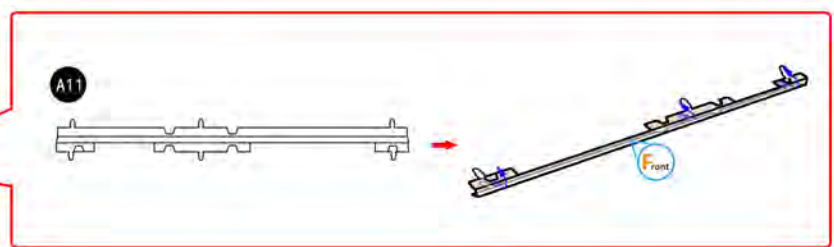
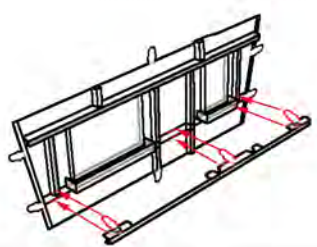
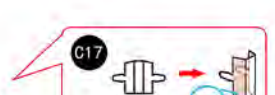
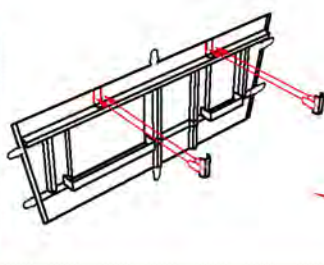
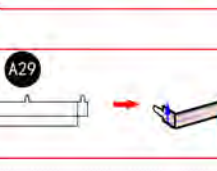
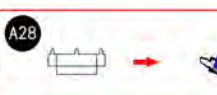
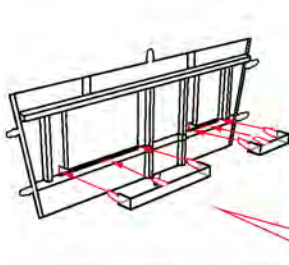
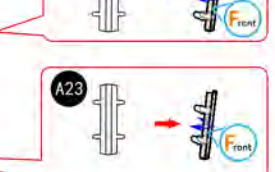
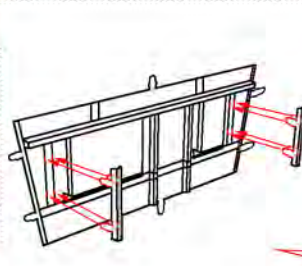
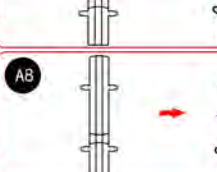
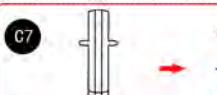
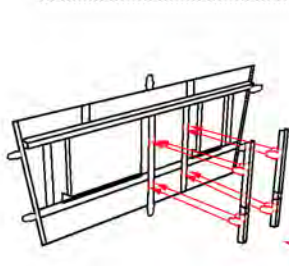
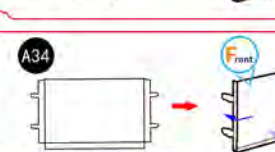
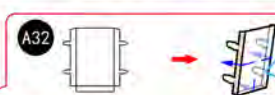
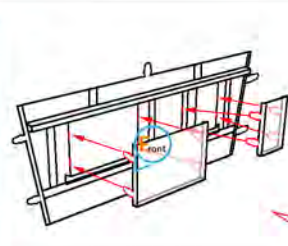
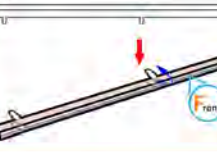
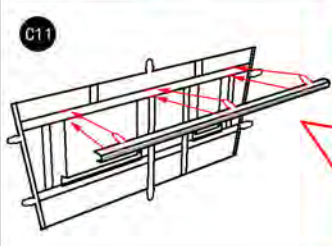

6

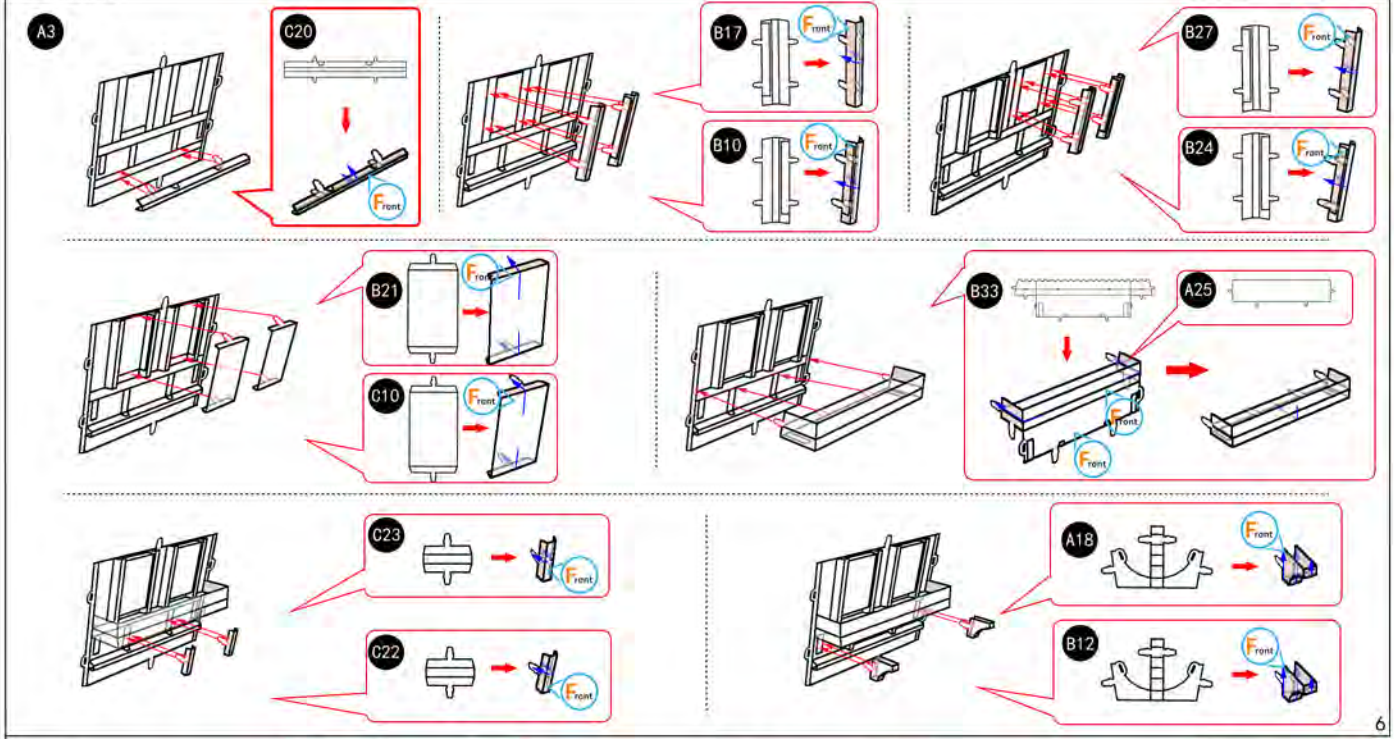

6

7

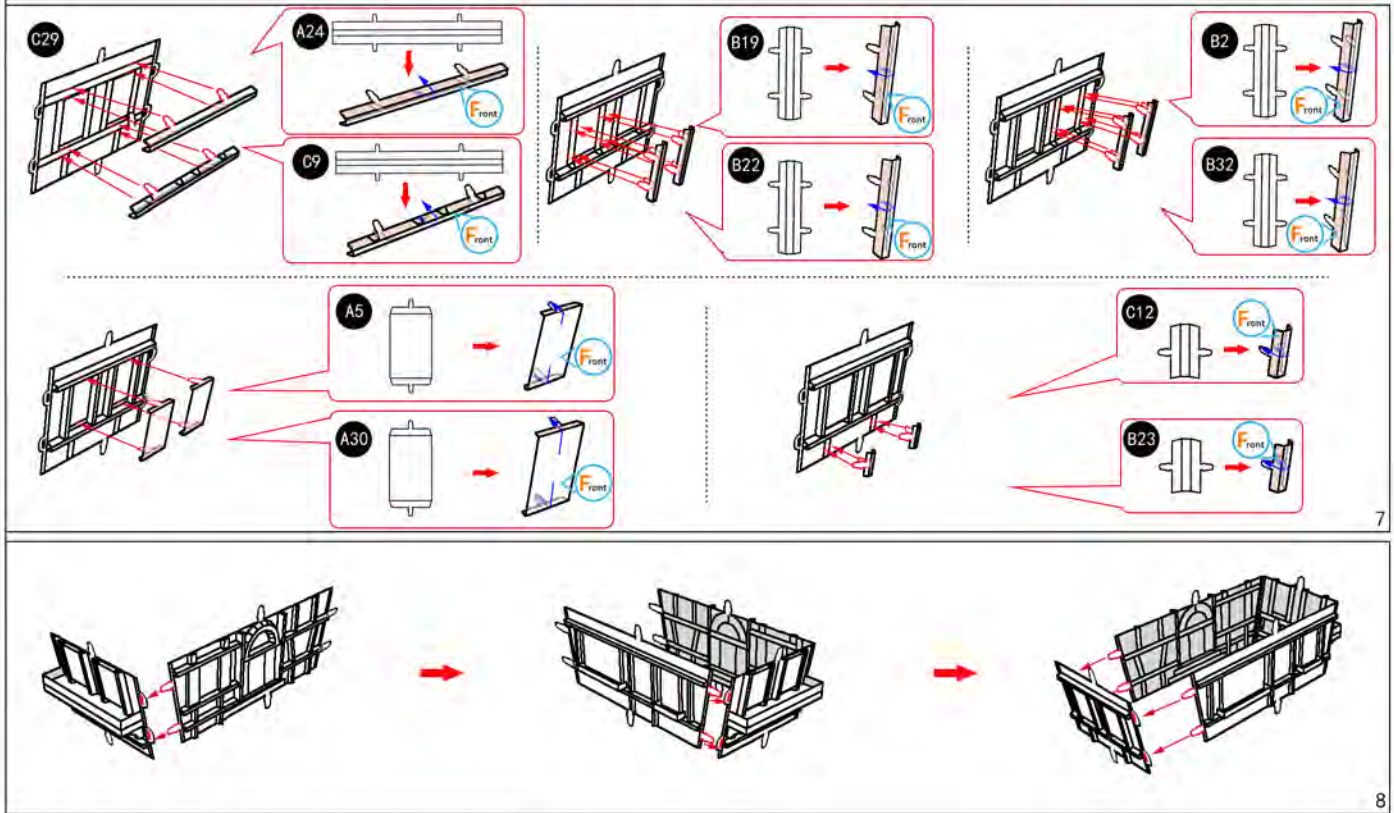

8



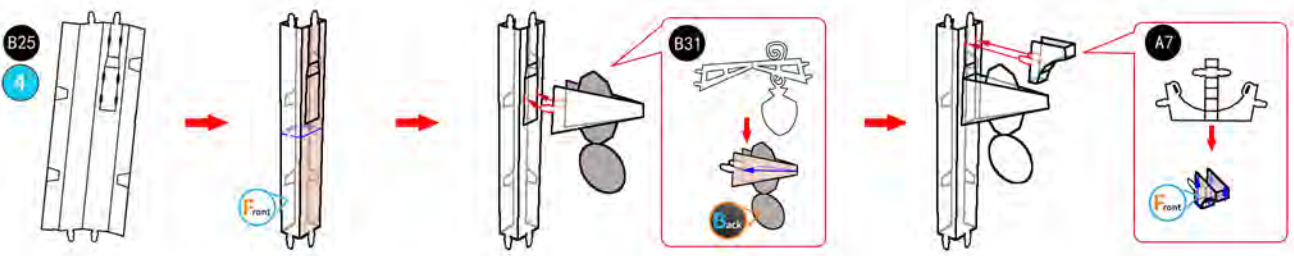
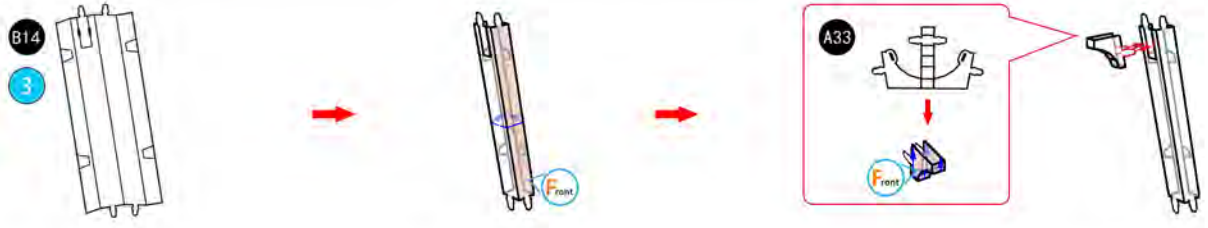
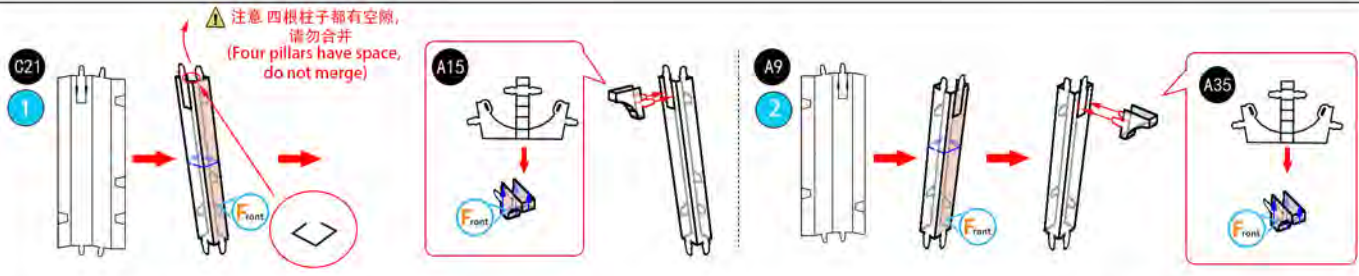
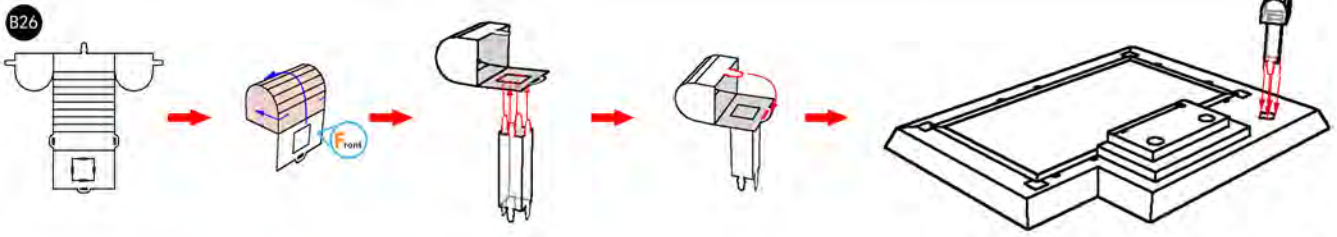
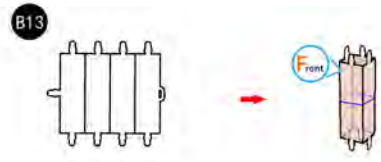
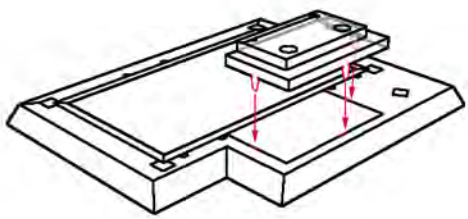
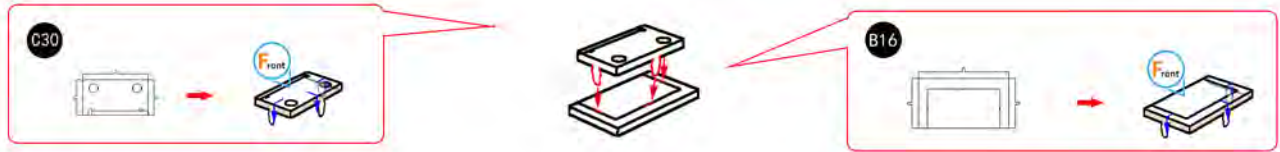

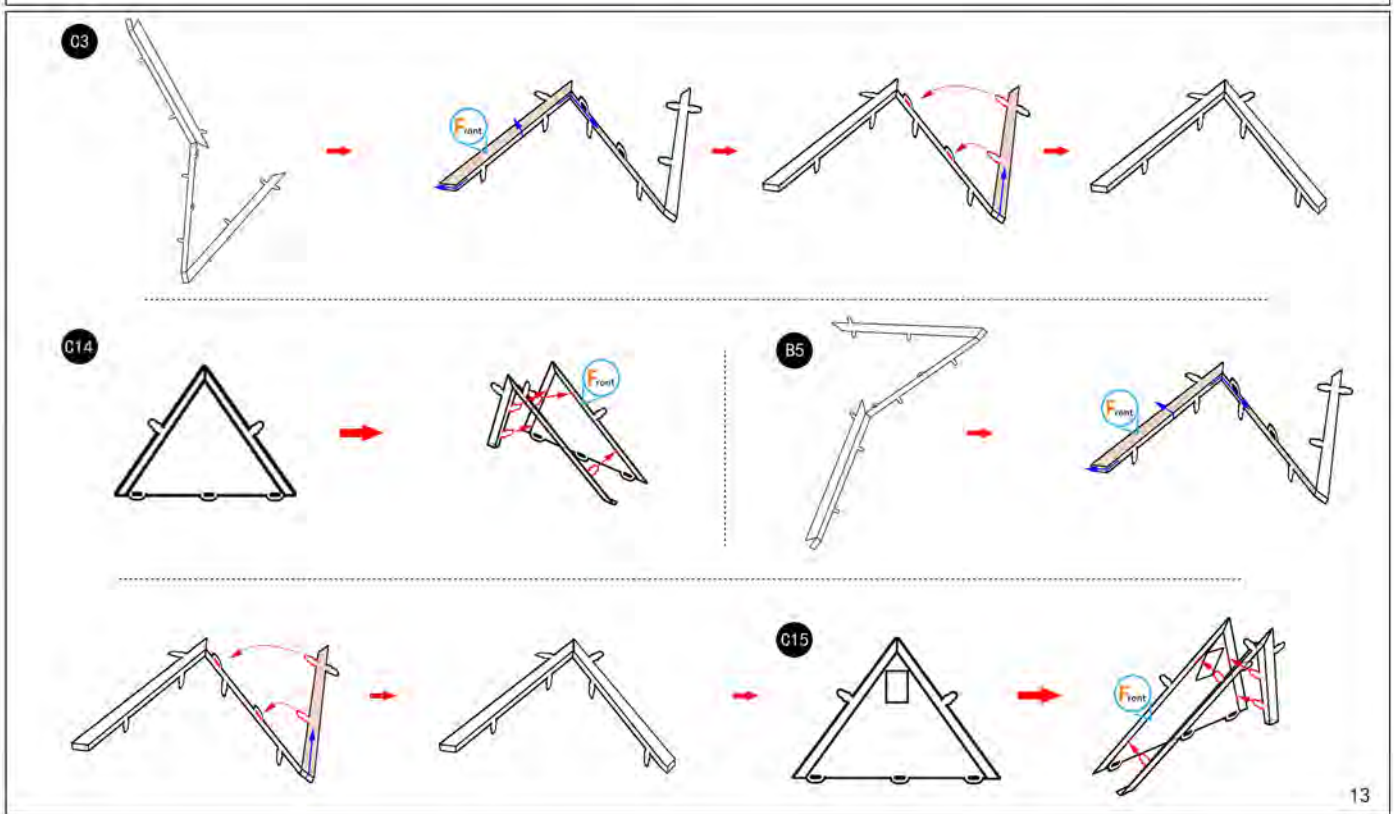
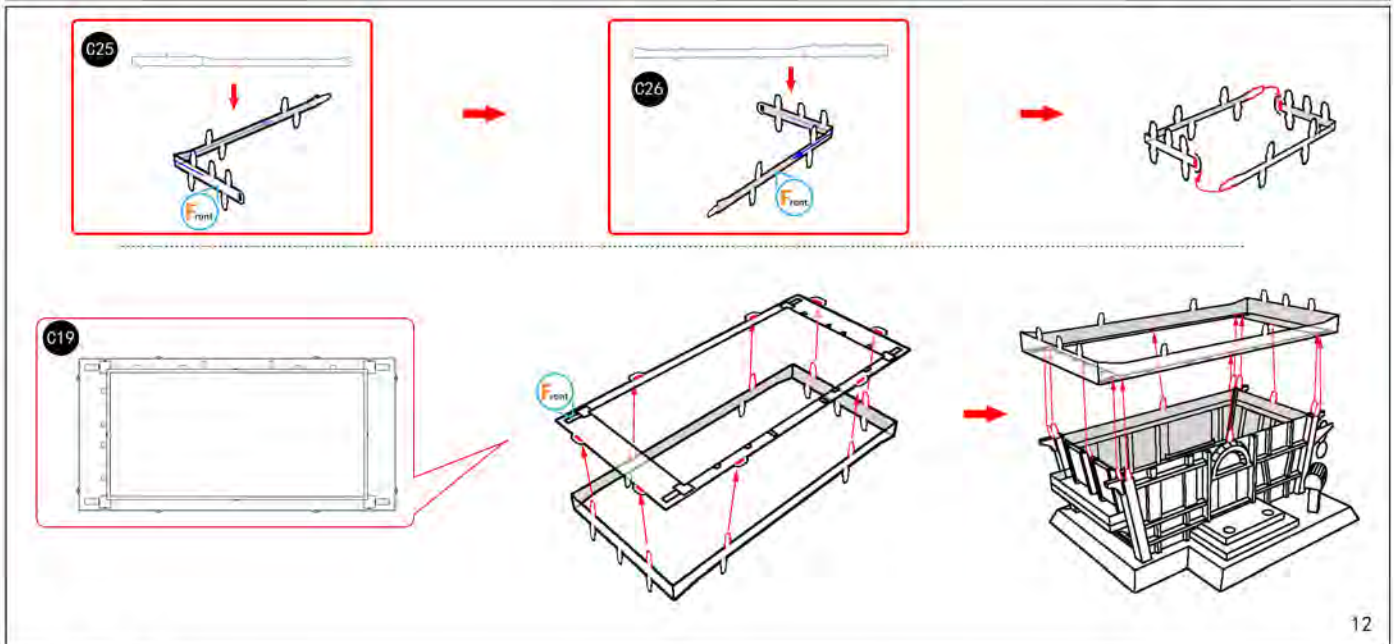
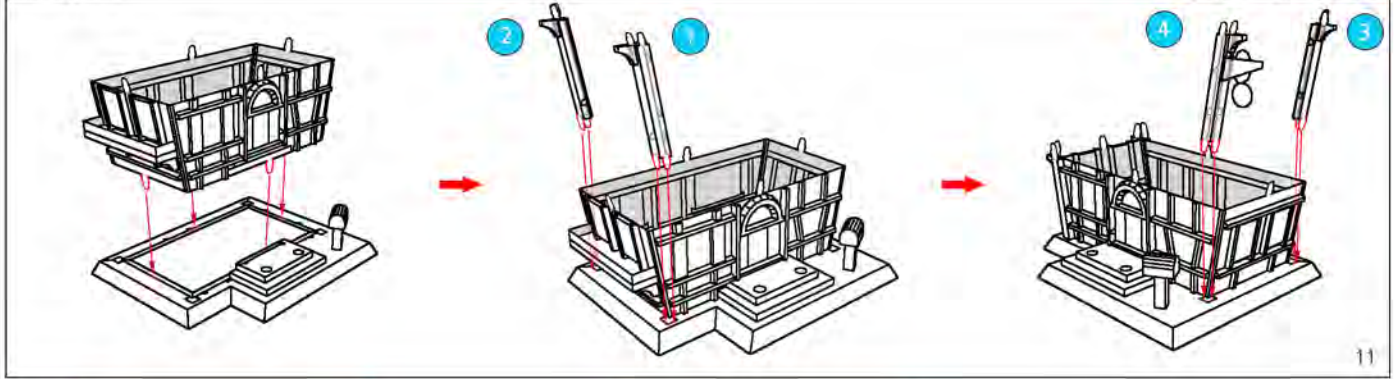

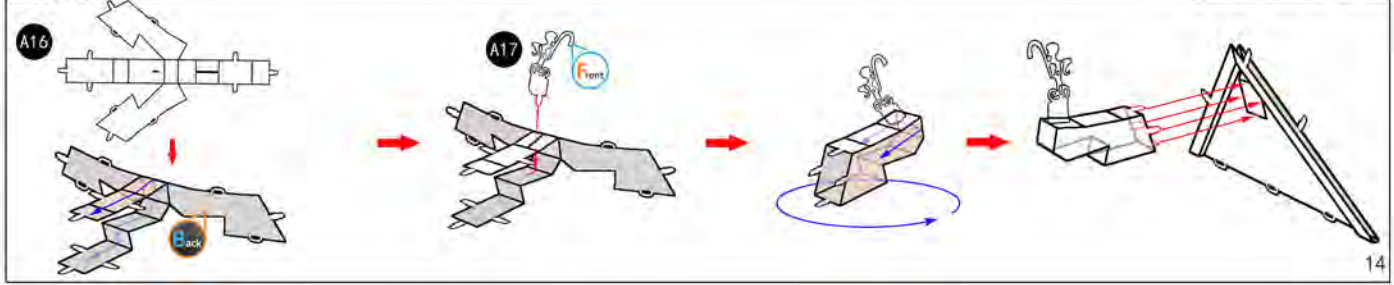

14

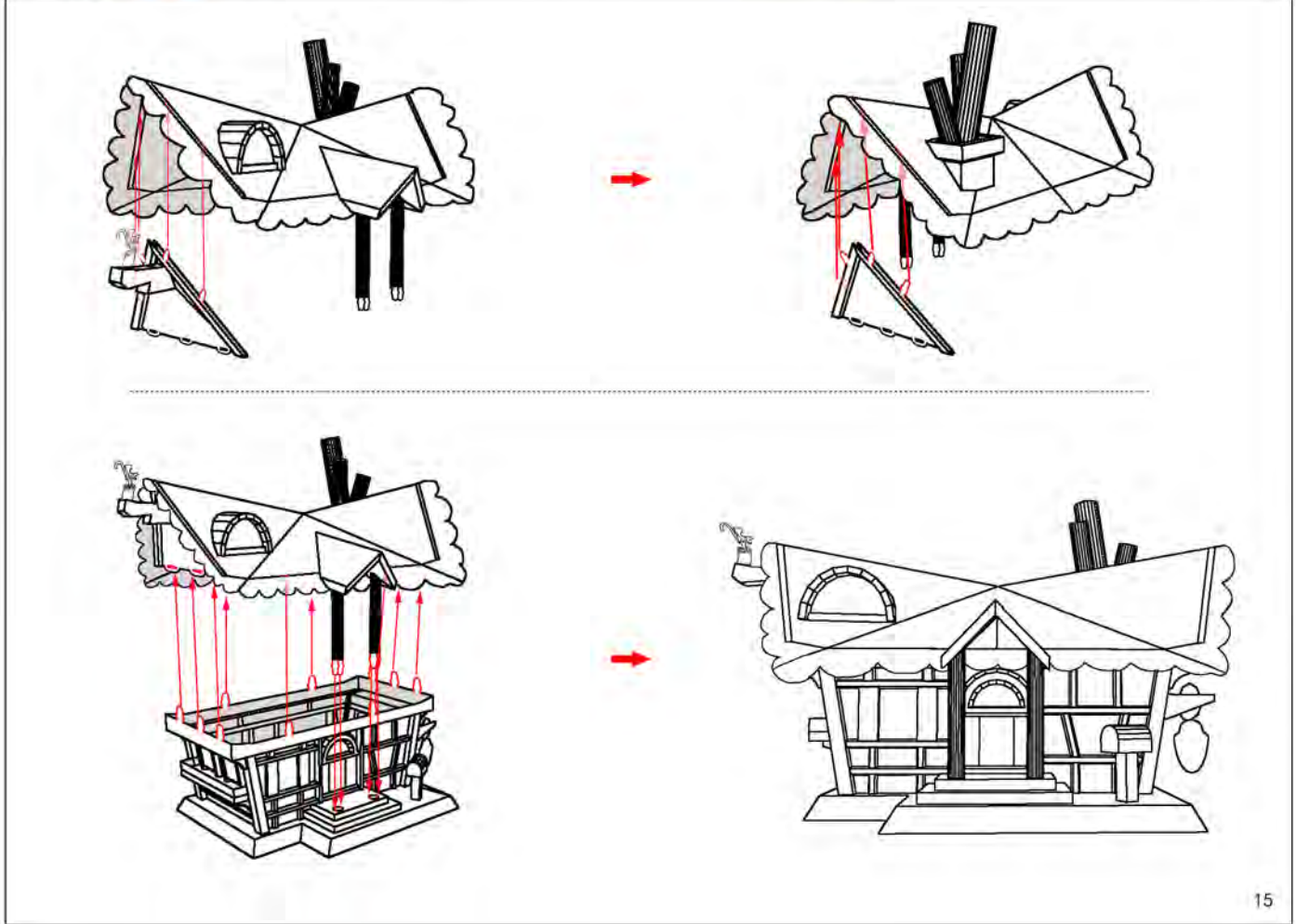

15



**艺模**

**上海艺模电子科技有限公司**  
SHANGHAI ART MODEL ELECTRONIC SCIENCE AND TECHNOLOGY CO.,LTD

电话/Tel: 021-58942999  
网址/Website: WWW.MAPLEMU.COM  
产地/Address: 上海浦东新区川周公路5917弄1号

Design by: 因幡Temi  
Remember  
铁板鱿鱼  
不吃榴莲

扫码加入微信公众号  
解锁更多模型  
Scan the two-dimensional code  
Join us and unlock more models

