

成品示意图 360° VIEW PICTURE

组装基本步骤示意图

BASIC ASSEMBLING STEPS

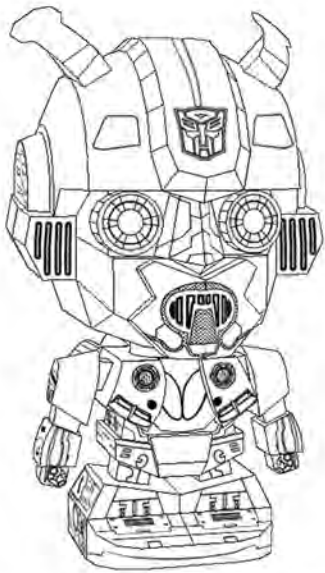

大黄蜂
BUMBLEBEE

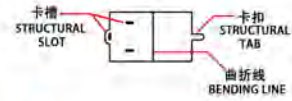
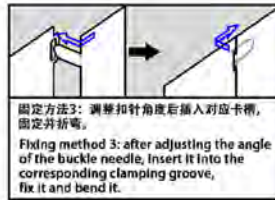
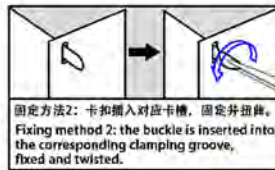

- 优先安装 Priority installation
- 折弯面 Bending Surface
- 纹理面 Textured surface
- 非纹理面 Non Textured Surface
- 组装前请戴上指套! Please wear a finger cover before assembly!
- 版件上刻有编号 Sheet metal pieces of the engraved with serial number
- 安装前可适当调整卡扣角度! Adjust the Angle of buckle properly before installation!
- 部分零件有备用件 Some parts have spare parts!

金属部件 METAL SHEET

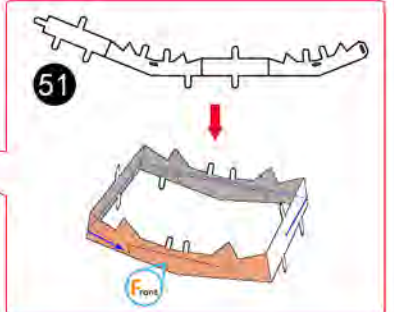
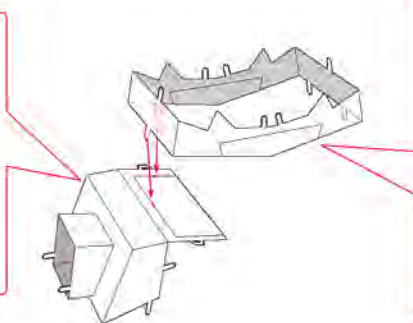
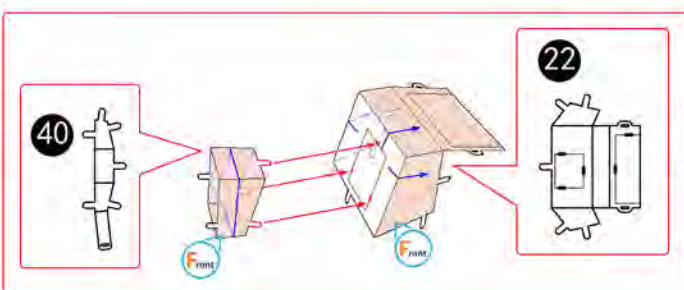
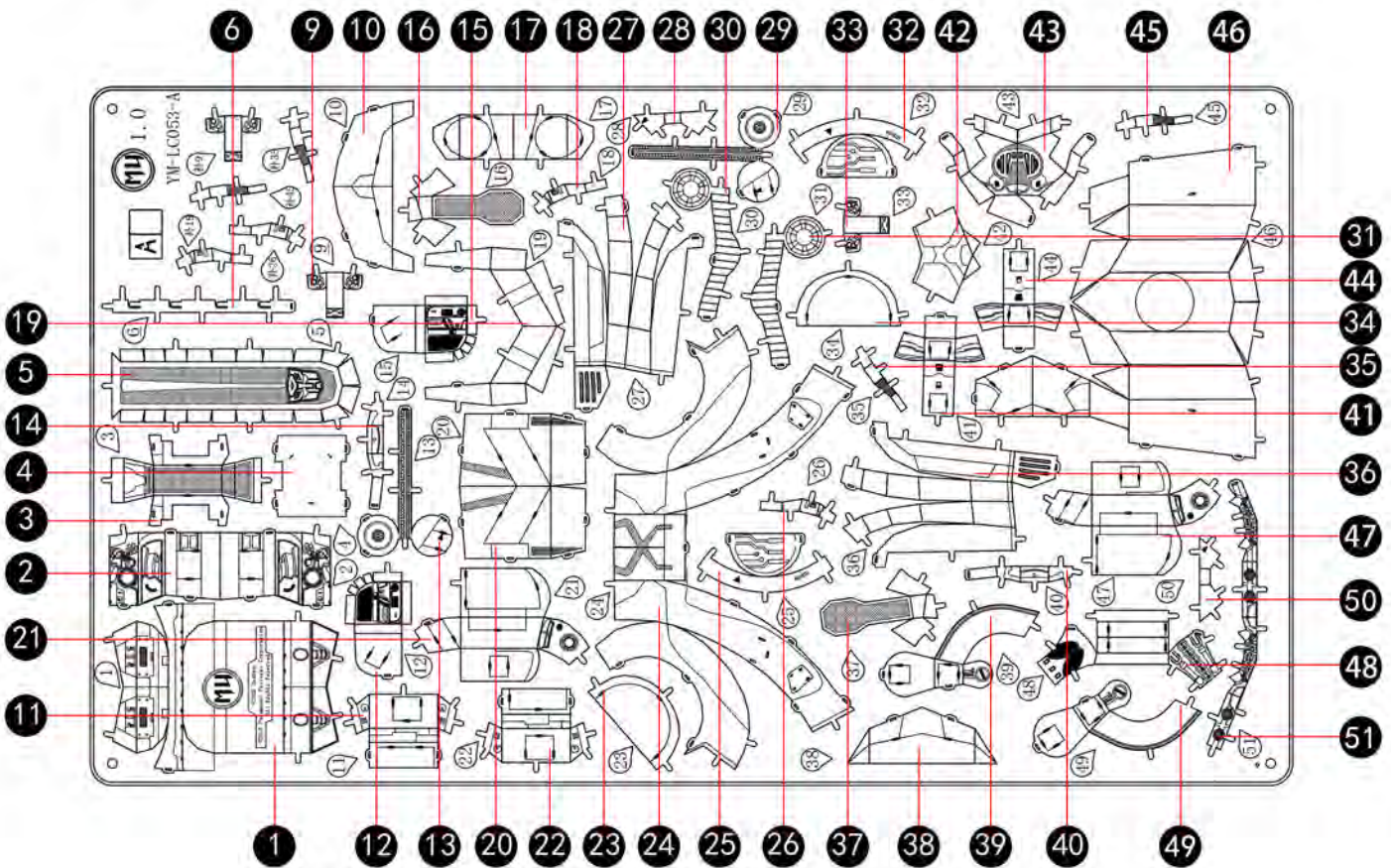

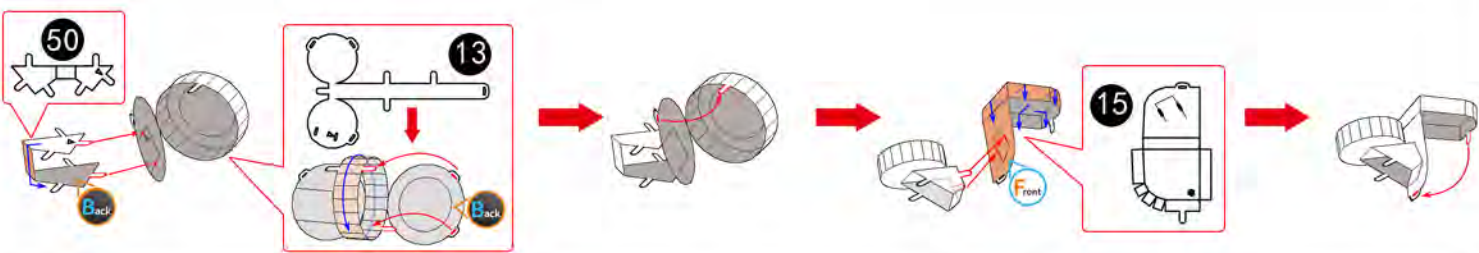
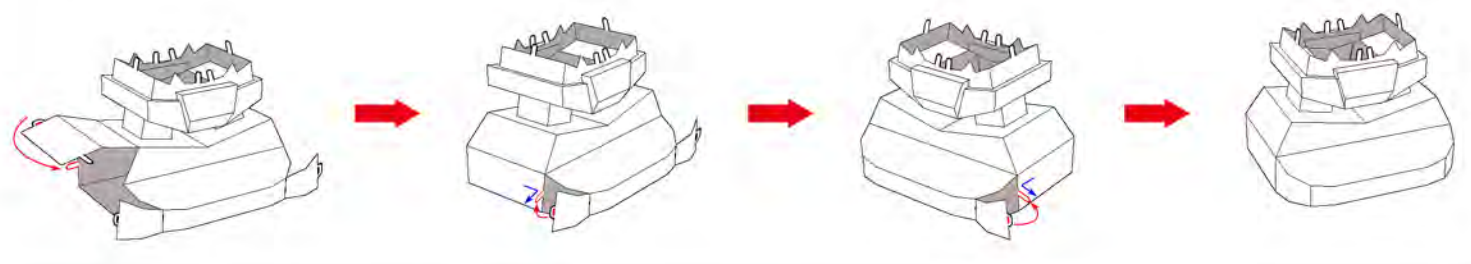
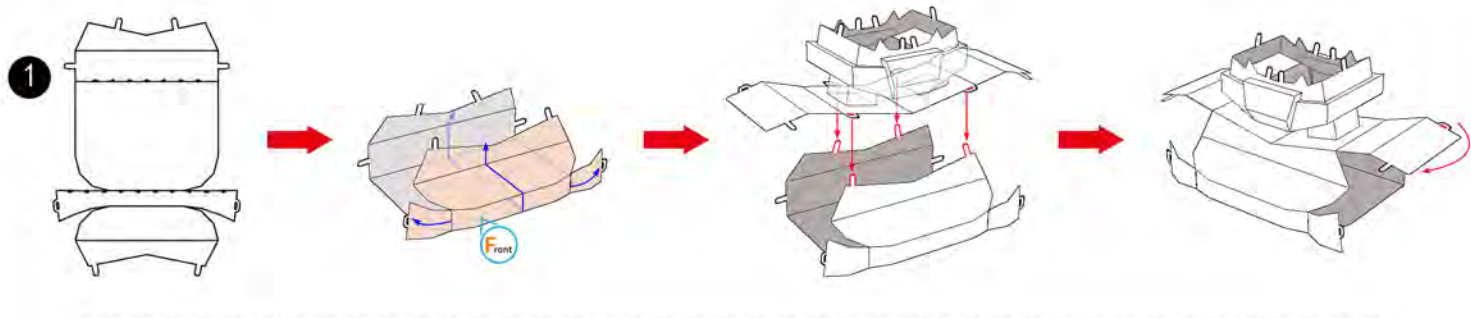
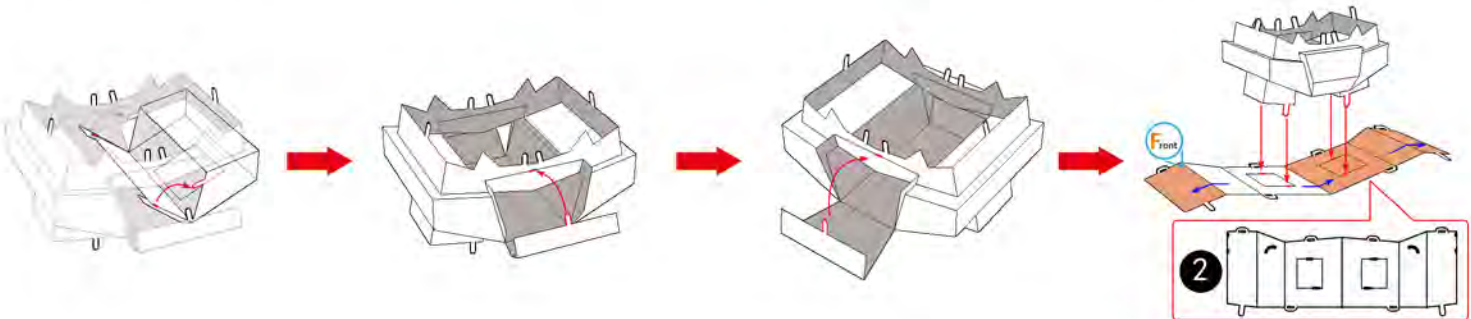
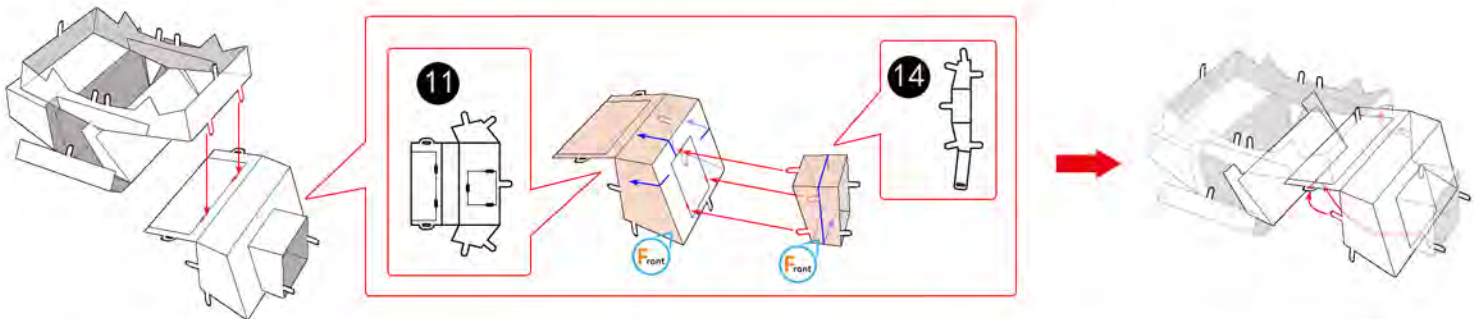
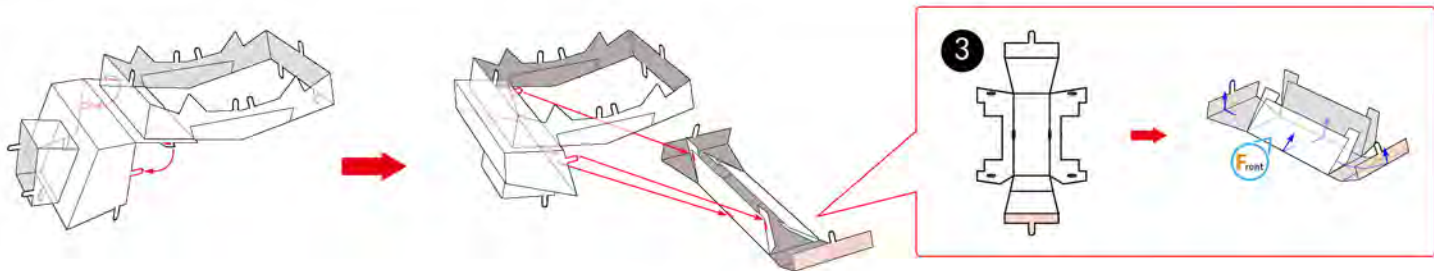

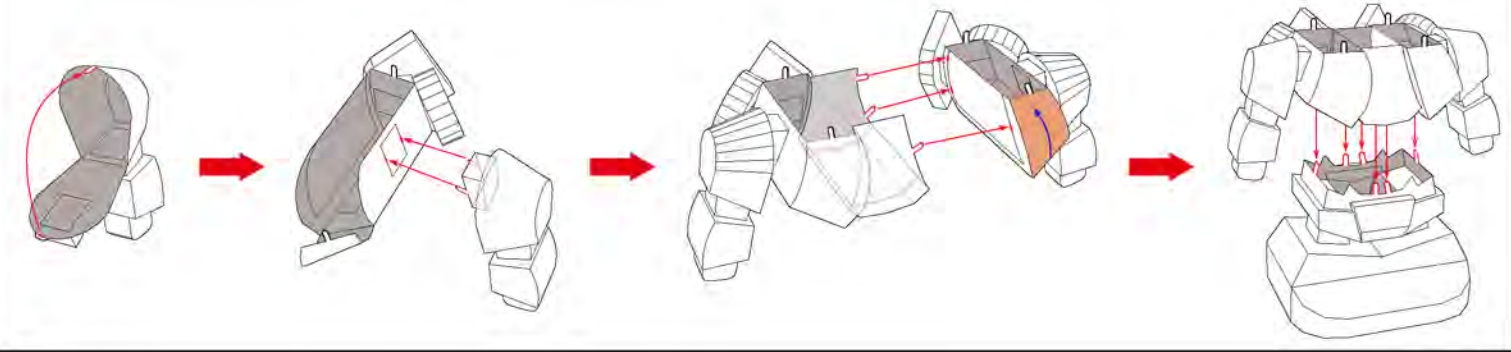
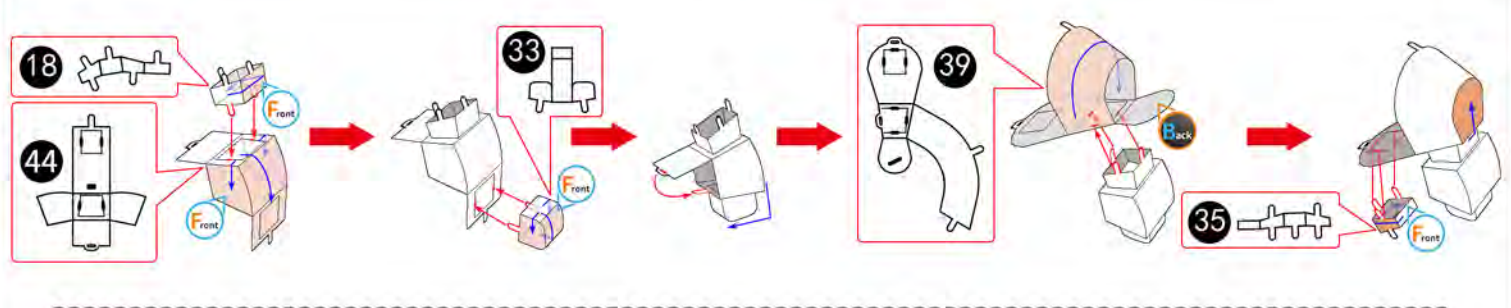
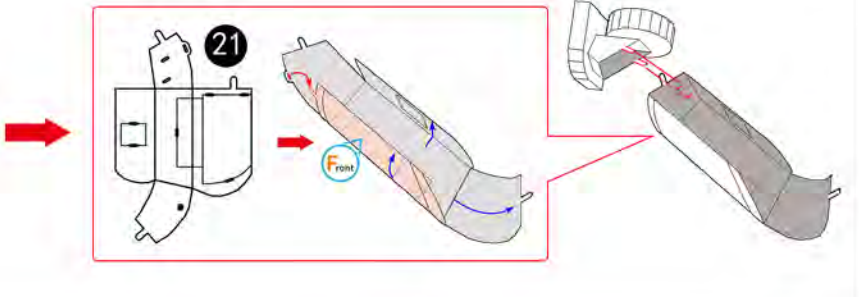
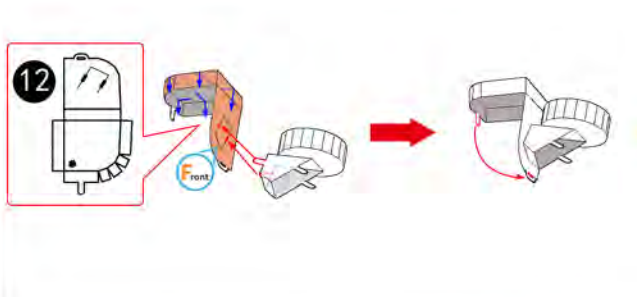
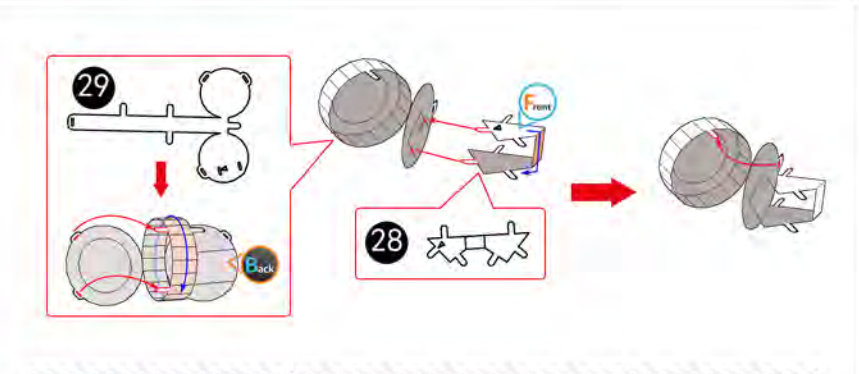
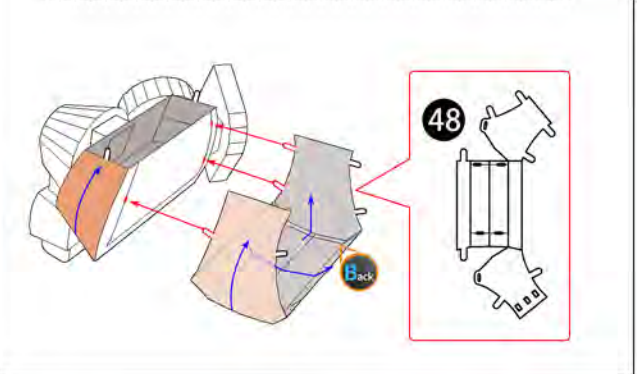
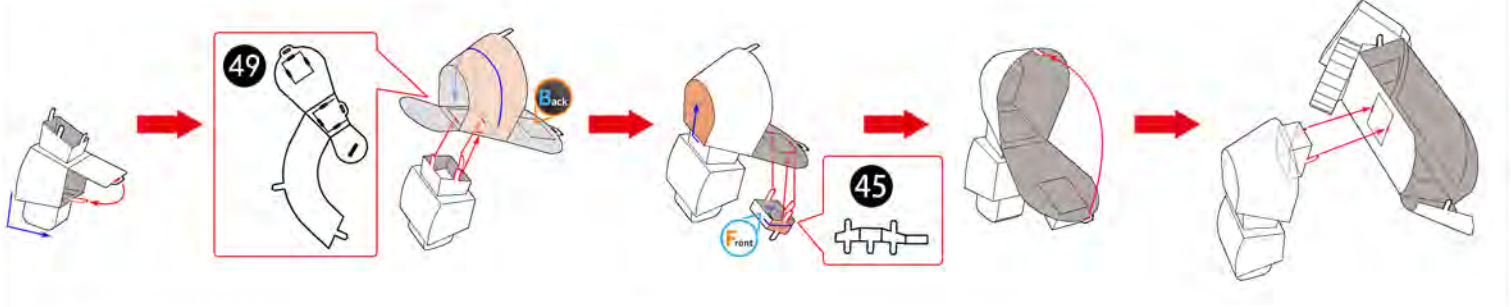
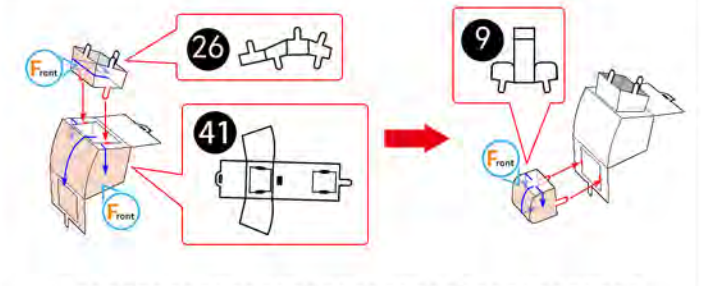
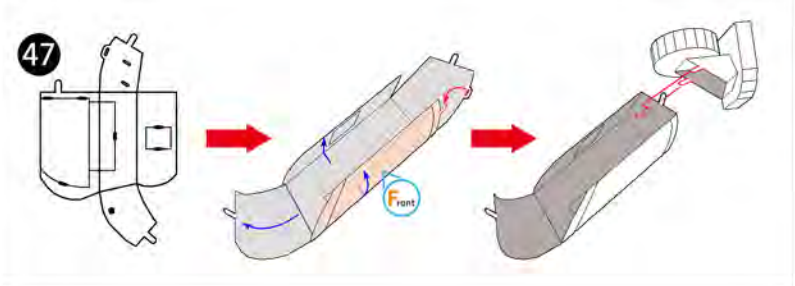

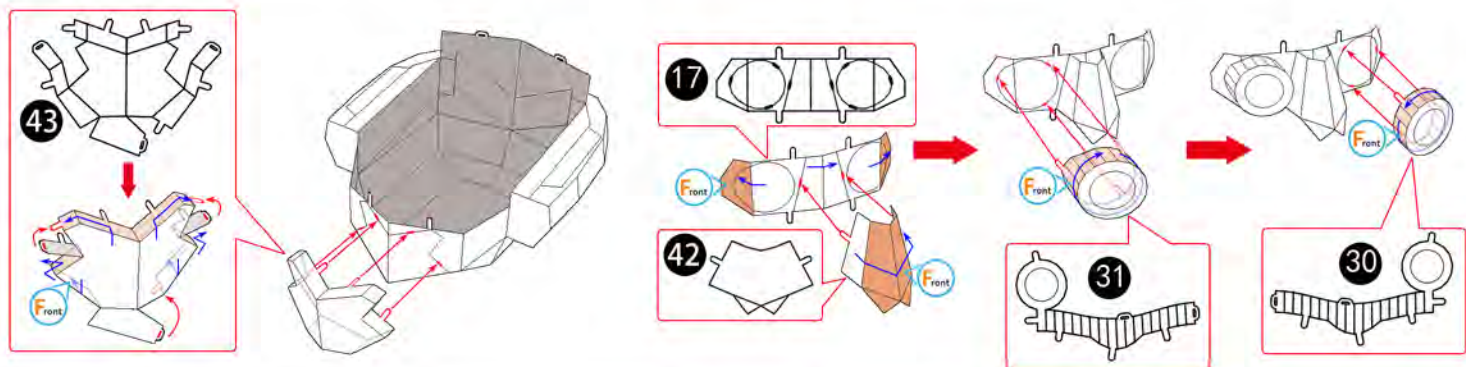
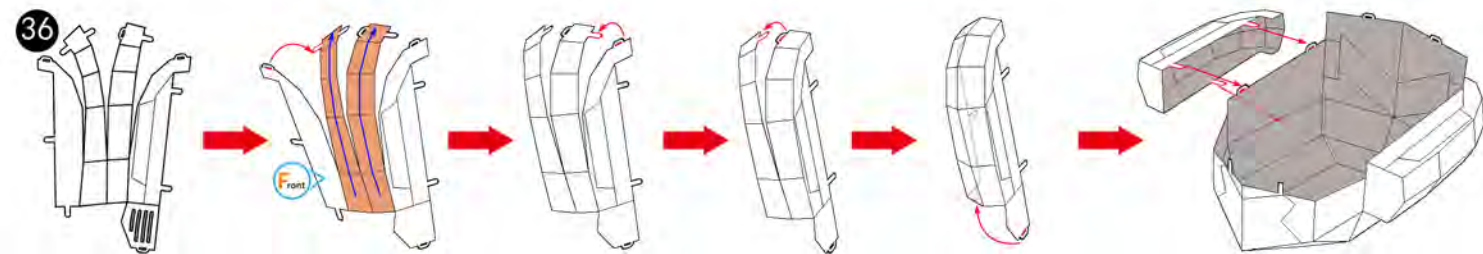
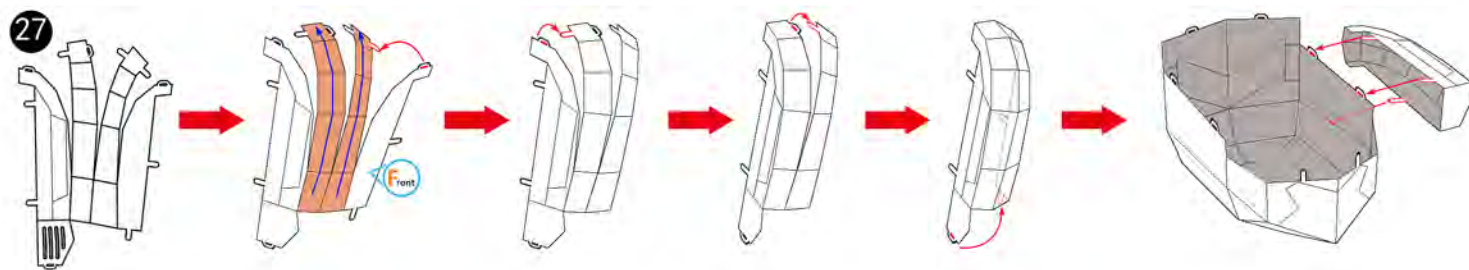
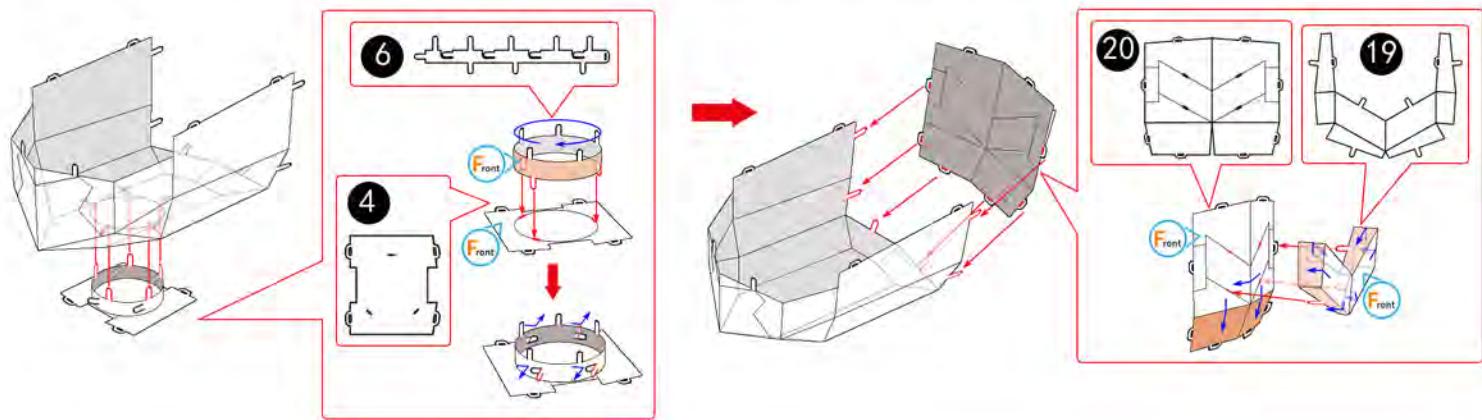
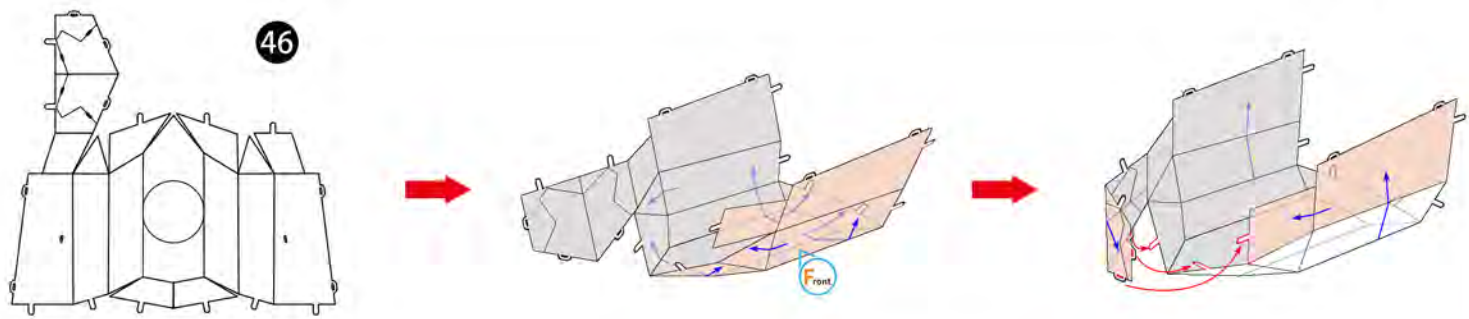

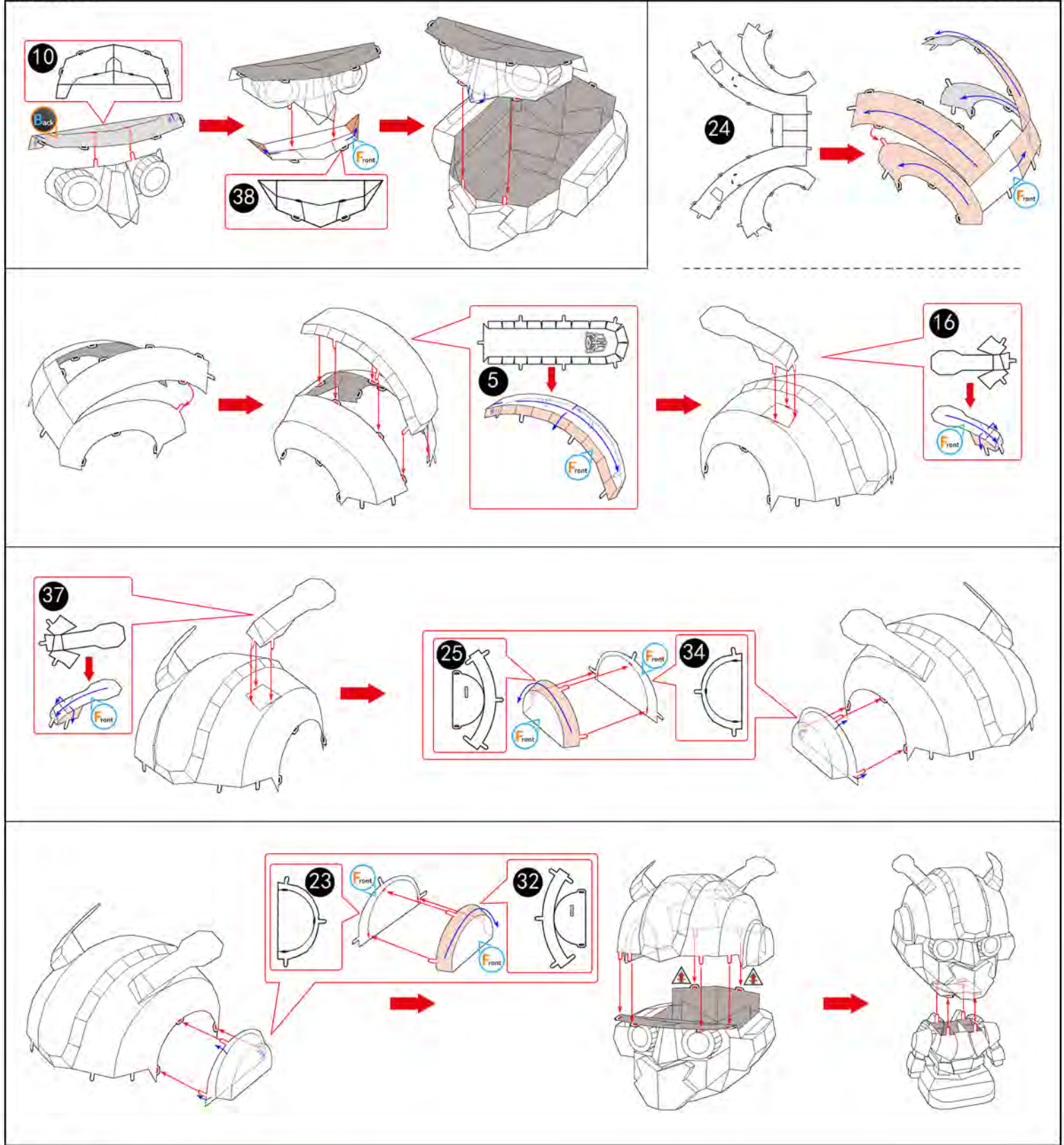

艺模

上海艺模电子科技有限公司

SHANGHAI ART MODEL ELECTRONIC SCIENCE AND TECHNOLOGY CO.,LTD

电话/Tel: 021-58942999

网址/Website: WWW.MUMODEL.COM

产地/Address: 上海浦东新区川周公路5917弄1号

Design by: 困囿Tewi
少游
Icewine

扫码加入微信公众号
解锁更多模型

Scan the two-dimensional code
Join us and unlock more models

